

REV/VER	DESCRIPTION OF CHANGE
AA	INITIAL RELEASE

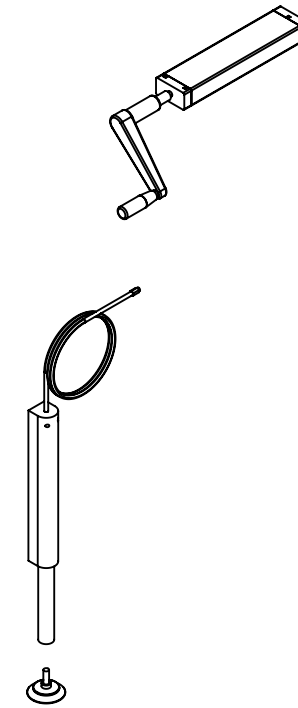
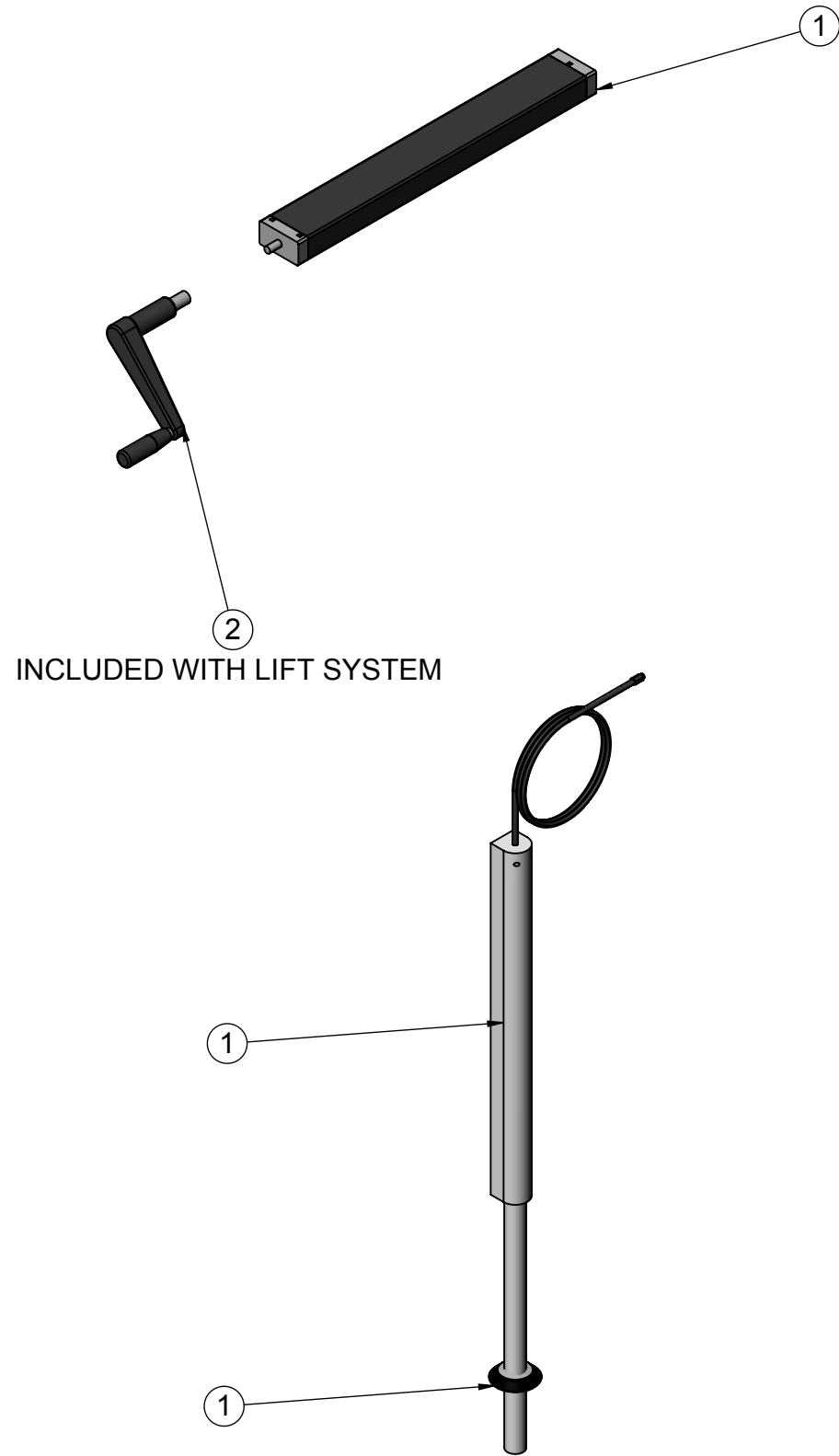

ITEM NO.	QTY.	ADDITIONAL DESCRIPTION	VENDOR	VENDOR PN
1	1	PUMP HOUSING	ERGOSOURCE	LM4X14
2	1	HANDLE	ERGOSOURCE	LH-05ES

STANDARD TOLERANCES UNLESS OTHERWISE SPECIFIED DIMENSIONS ARE IN INCHES.		DRAWN BY LUCID LABS	DATE 24JUN2013	ErgoSource	THIS DRAWING AND INFORMATION CONTAINED THEREON ARE CONFIDENTIAL AND THE PROPERTY OF ErgoSource. ANY USE OR REPRODUCTION OF THIS DRAWING IS EXPRESSLY PROHIBITED WITHOUT LUCID LABS CONSENT.
INCH .X ±.1 .XX ±.05 ANGLES ±2°		TITLE 4X LIFT SYSTEM			
MATERIAL NA			DWG SIZE B		DOCUMENT NUMBER LM1X14
SURFACE TREATMENT (UNLESS OTHERWISE SPECIFIED DIMENSIONS APPLY PRIOR TO TREATMENT) NA			DO NOT SCALE		REV/VER SHEET 1 OF 3

SOLIDWORKS

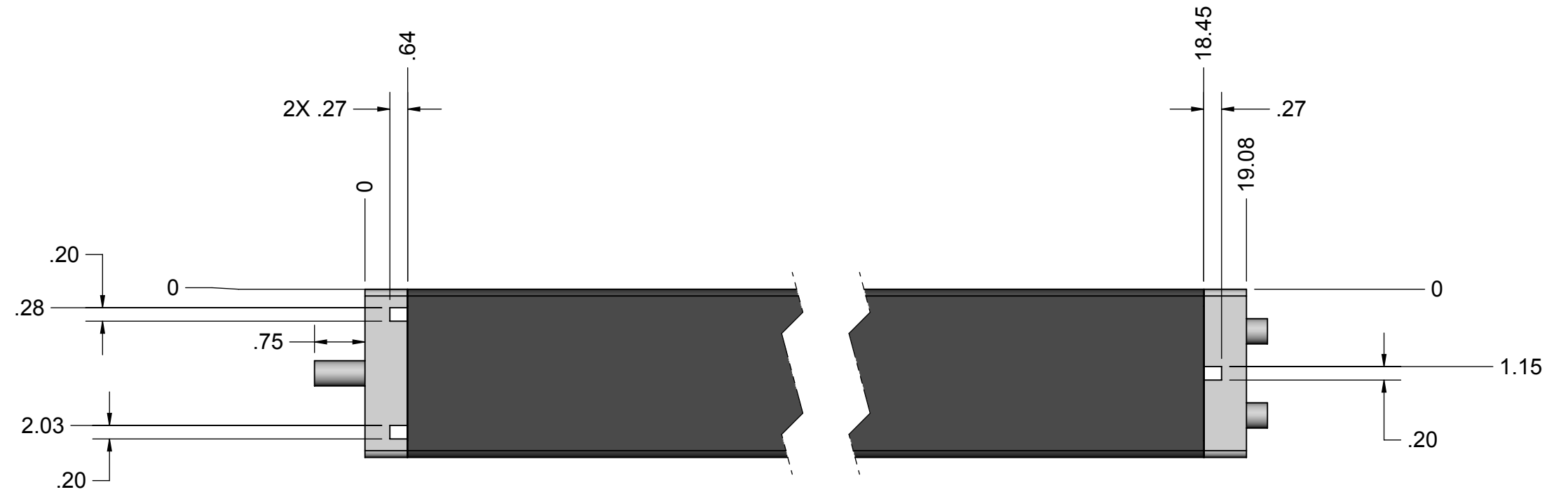
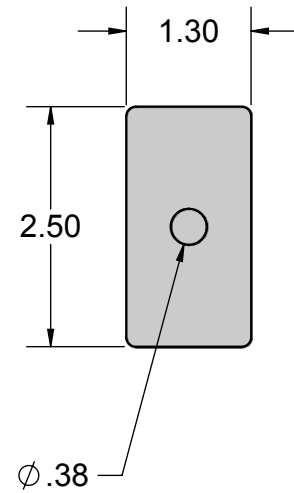
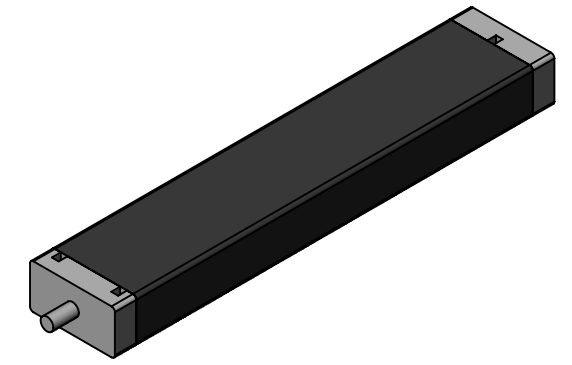

STANDARD TOLERANCES UNLESS OTHERWISE SPECIFIED DIMENSIONS ARE IN INCHES.		DRAWN BY LUCID	DATE 18AUG2012	Ergosource	THIS DRAWING AND INFORMATION CONTAINED THEREON ARE CONFIDENTIAL AND THE PROPERTY OF Ergosource. ANY USE OR REPRODUCTION OF THIS DRAWING IS EXPRESSLY PROHIBITED WITHOUT LUCID LABS CONSENT.												
<table border="1"> <tr> <th>INCH</th> <th></th> <th>mm</th> <th></th> </tr> <tr> <td>X</td> <td>±.2</td> <td>X</td> <td>± 5.08</td> </tr> <tr> <td>.XX</td> <td>±.1</td> <td>.X</td> <td>± 2.54</td> </tr> </table>	INCH		mm			X	±.2	X	± 5.08	.XX	±.1	.X	± 2.54	TITLE PUMP HOUSING PUMP HOUSING			
INCH		mm															
X	±.2	X	± 5.08														
.XX	±.1	.X	± 2.54														
ANGLES ±2°				DWG SIZE B	 THIRD ANGLE PROJECTION	DOCUMENT NUMBER LM1X14	REV/VER										
MATERIAL NA				DO NOT SCALE		SHEET 2 OF 3											
SURFACE TREATMENT (UNLESS OTHERWISE SPECIFIED DIMENSIONS APPLY PRIOR TO TREATMENT) NA																	

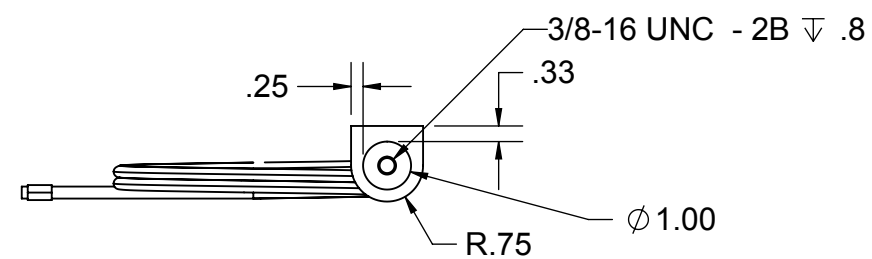
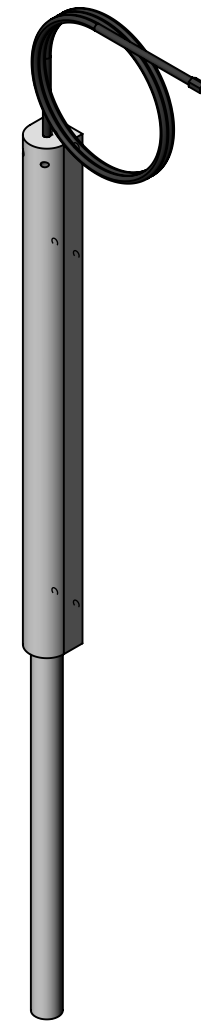
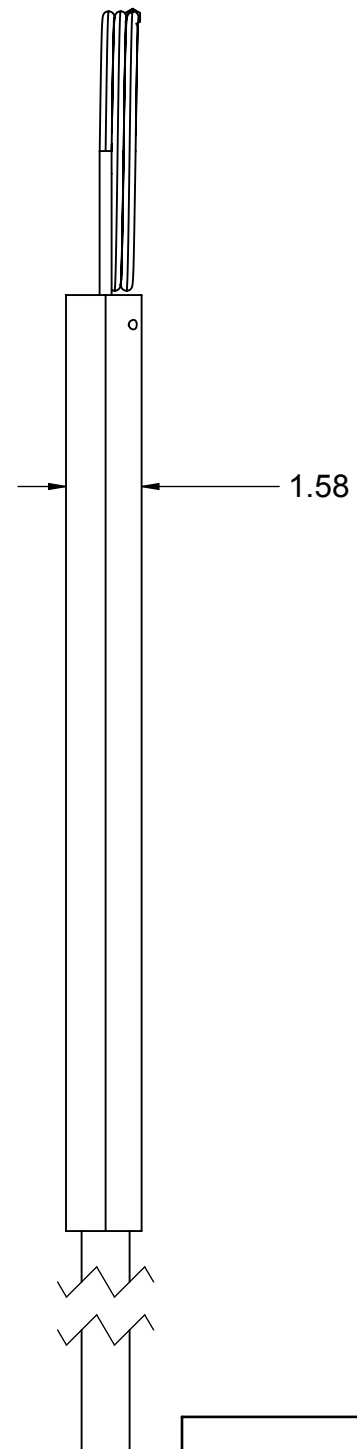
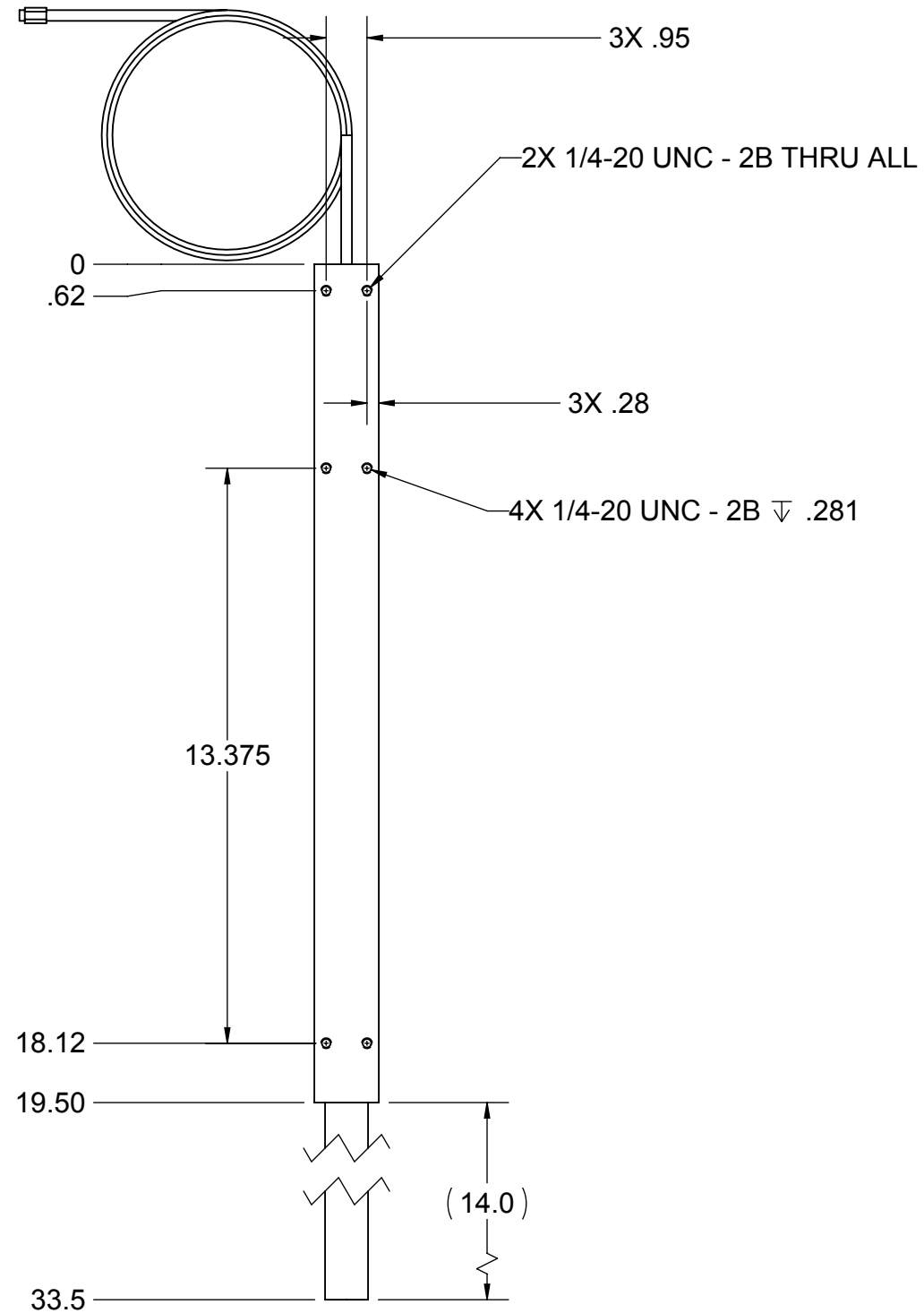

STANDARD TOLERANCES UNLESS OTHERWISE SPECIFIED DIMENSIONS ARE IN INCHES.		DRAWN BY LUCID	DATE 18AUG2012	ErgoSource	THIS DRAWING AND INFORMATION CONTAINED THEREON ARE CONFIDENTIAL AND THE PROPERTY OF ErgoSource. ANY USE OR REPRODUCTION OF THIS DRAWING IS EXPRESSLY PROHIBITED WITHOUT LUCID LABS CONSENT.	
INCH .X \pm .1 .XX \pm .05		TITLE X-HOUSING				
ANGLES \pm 2°				DWG SIZE B	THIRD ANGLE PROJECTION	DOCUMENT NUMBER LM1X14
MATERIAL NA				DO NOT SCALE	REVISIONS	REV/VER
SURFACE TREATMENT (UNLESS OTHERWISE SPECIFIED DIMENSIONS APPLY PRIOR TO TREATMENT) NA				SHEET	3 OF 3	